

12

FRIENDS
BY bene

9



5

USER MANUAL
WALL CLOCK



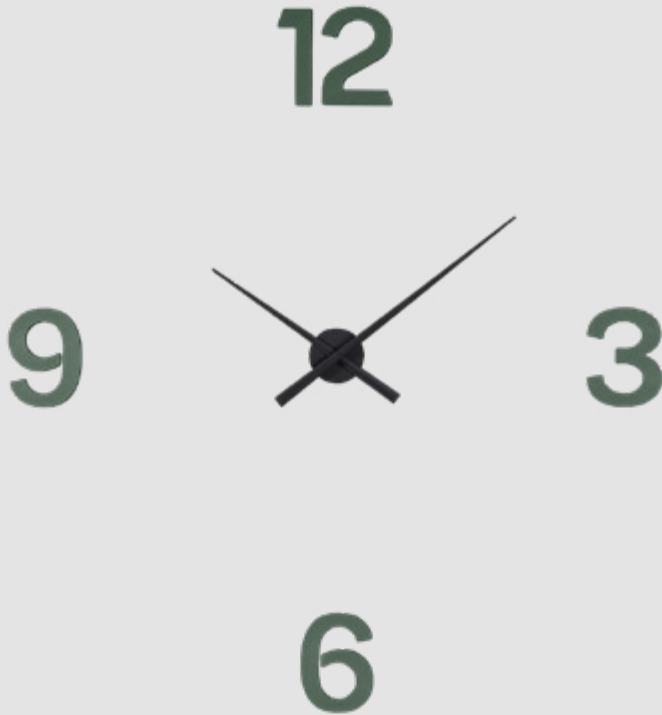

RECOMMENDATIONS

- Please read the following instructions carefully and use the product accordingly.
- This summary may not include every detail of all variations and considered steps. Please contact us should you require further information or help at any time.
- Please assemble this product in accordance with the instructions.
- Wipe clean with a dry cloth for daily care.
- Should you find that you are missing /or that you have received defective parts after unpacking, please contact us immediately and do not attempt to assemble the product.

WARNINGS

- Before using bFRIENDS Wall Clock, make sure it is mounted safely and correctly.
- PLA becomes malleable and soft above 50 °C. 3D-Printed parts of bFRIENDS are therefore not suitable for cleaning in the dishwasher and should be kept away from heat sources.

1. Use a clean cloth to wipe the chosen wall area before mounting your bFRIENDS wall clock.

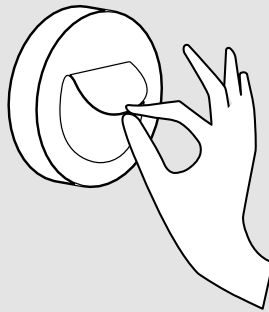

2. Remove the adhesive cover and stick the wall mount (back part) to the wall.

3. Fix the cover plate to the wall mount, to close the element, and attach the hands: First insert the (smaller) hour hand, followed by the (larger) minute hand by pushing them carefully onto the clock's spindle.

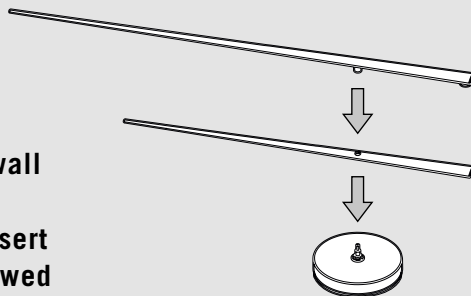

4. Set both hands at 12 o'clock.

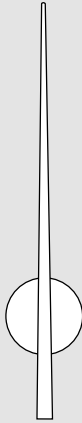

5. To help you to position the digits at the correct distance please use the provided measuring template.

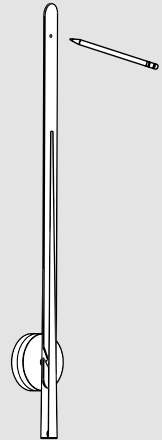

6. Hook the template around the clock's central spindle, between the two hands. Using the pin hole at the top of the template make a mark on the wall that corresponds to the position of the hour digits you've chosen.

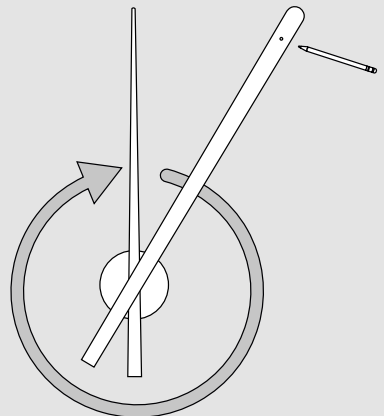

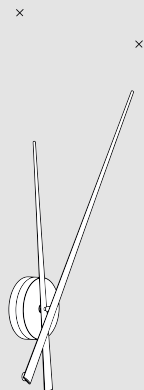

7. Turn the minute hand 360 degrees, to automatically move the hour hand into the correct position. Then using the template make your mark. Repeat this process until you've made all the marks for chosen hour digits.

8. Insert the pins into the fixing holes on the backside of the digits. Then, attach the adhesive dots to them.

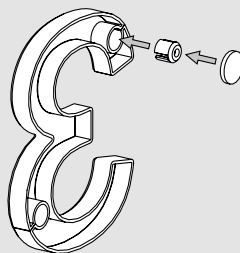

9. Remove the cover from the adhesive dots and affix the digits to their correct position.

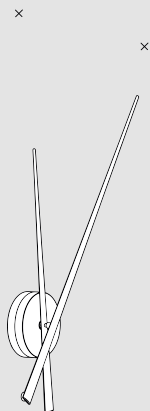

Bene GmbH
Schwarzwiesenstrasse 3
3340 Waidhofen/Ybbs
Austria

BENE.COM



bene

INSPIRING OFFICES. SINCE 1790.